

DRUM WASHING  
MACHINE MODEL:FL914L21W

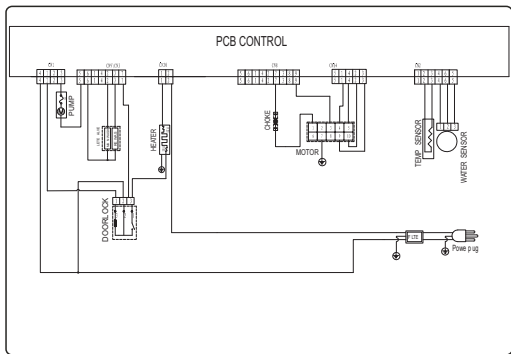

NORMAL LOAD	9.0kg
RATED VOLTAGE	220 240V~
MAX. CURRENT	10A
RATED FREQUENCY	50Hz
RATED POWER	2000W
WATER PRESSURE	0.05 1MPa
GRADE OF WATERPROOF	IPX4



Importer:xxx

Manufacturer: